



Head Support



51010



51014 shown on chair



51022

One Piece Curved Head Rest Kit

Complete with pad, ball & socket pad mount, and choice of removable or flip down style main mounting. Pads are covered with water resistant/barrier stretch fabric.

ITEM #	DESCRIPTION	PAD SIZE	MOUNTING
51010	SMALL CURVED OVAL HEAD REST KIT	6.5" X 4"	REMOVABLE
51020	SMALL CURVED OVAL HEAD REST KIT	6.5" X 4"	FLIP DOWN
51012	MEDIUM CURVED OVAL WINGED HEAD REST KIT	10" X 4.5"	REMOVABLE
51022	MEDIUM CURVED OVAL WINGED HEAD REST KIT	10" X 4.5"	FLIP DOWN
51014	LARGE CURVED OVAL WINGED HEAD REST KIT	14" X 4.5"	REMOVABLE
51024	LARGE CURVED OVAL WINGED HEAD REST KIT	14" X 4.5"	FLIP DOWN

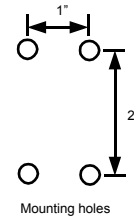

Please see page 14 for mounting adapter plates



51052 shown on chair



Adjustable width and angle side pads



51052

Three Piece Multi-adjustable Head Rest Kit

Complete with pads, ball & socket main mount, and choice of removable or flip down style back rest mounting. Adjustable width and ball & socket side pads with ear cutouts. Pads are covered with water resistant/barrier stretch fabric.

ITEM #	DESCRIPTION	CENTER PAD SIZE	SIDE PAD SIZE	MOUNTING
51050	SMALL 3-PIECE MULTI-ADJ. HEAD REST KIT	5"W X 4"H	4"W X 3.5"H	REMOVABLE
51060	SMALL 3-PIECE MULTI-ADJ. HEAD REST KIT	5"W X 4"H	4"W X 3.5"H	FLIP DOWN
51052	MEDIUM 3-PIECE MULTI-ADJ. HEAD REST KIT	5"W X 4"H	5"W X 3.5"H	REMOVABLE
51062	MEDIUM 3-PIECE MULTI-ADJ. HEAD REST KIT	5"W X 4"H	5"W X 3.5"H	FLIP DOWN
51054	LARGE 3-PIECE MULTI-ADJ. HEAD REST KIT	6"W X 5"H	6"W X 4"H	REMOVABLE
51064	LARGE 3-PIECE MULTI-ADJ. HEAD REST KIT	6"W X 5"H	6"W X 4"H	FLIP DOWN



Side view



Head Support



11000



11002

Small block head rest mounts

Block is only 1-1/2" x 3", self-locking mechanism.

ITEM #	DESCRIPTION	RECEIVER TYPE
11000	SMALL BLOCK HEAD REST MOUNT	7/16" ROUND
11002	SMALL BLOCK HEAD REST MOUNT	1/2" SQUARE



11000
flipped down



11004



11006

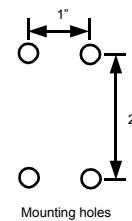

Please see page 14 for mounting adapter plates

Large block head rest mounts

Block size is 2" x 4" with a self-locking mechanism.

ITEM #	DESCRIPTION	RECEIVER TYPE
11004	LARGE BLOCK HEAD REST MOUNT	7/16" ROUND
11006	LARGE BLOCK HEAD REST MOUNT	1/2" SQUARE



Close up of 11006 split collar for 1/2" square tube



Head Support

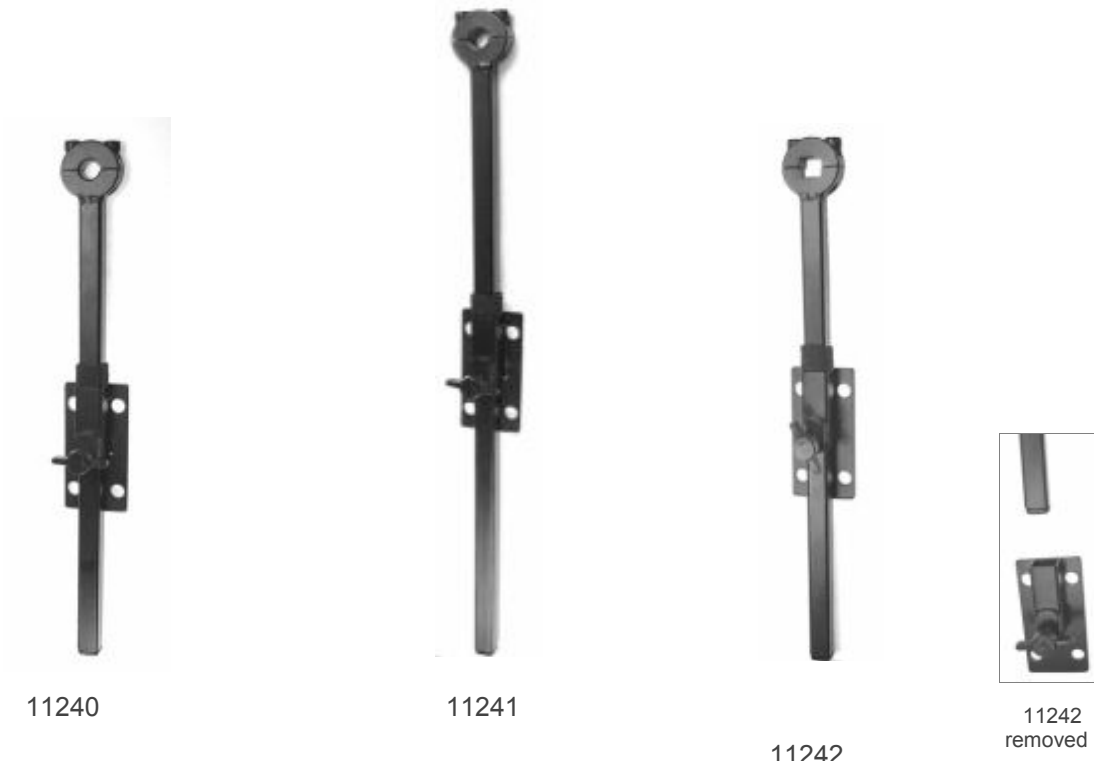

Removable straight head rest mounts

Available with round 7/16" collar or square 1/2" collar, non-marking type thumb screw lock and adjustable rubber stop. Custom lengths and hole patterns available.

ITEM #	DESCRIPTION	TUBE HEIGHT	RECEIVER TYPE
11240	REMOVABLE STRAIGHT HEAD REST MOUNT	10-1/4"	7/16" ROUND
11241	REMOVABLE STRAIGHT HEAD REST MOUNT - 4" EXTRA HEIGHT	14-1/4"	7/16" ROUND
11242	REMOVABLE STRAIGHT HEAD REST MOUNT	10-1/4"	1/2" SQUARE
11243	REMOVABLE STRAIGHT HEAD REST MOUNT - 4" EXTRA HEIGHT	14-1/4"	1/2" SQUARE

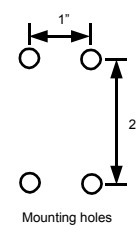

Please see page 14 for mounting adapter plates



Head Support



11245



11246



11247



11247 removed

Removable offset head rest mounts

Reversible 3" offset, available with round 7/16" collar or square 1/2" collar, non-marking type thumb screw lock and adjustable rubber stop. Custom lengths, offsets, and hole patterns available.

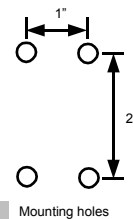

ITEM #	DESCRIPTION	TUBE HEIGHT	RECEIVER TYPE
11245	REMOVABLE OFFSET HEAD REST MOUNT	10-1/4"	7/16" ROUND
11246	REMOVABLE OFFSET HEAD REST MOUNT - 4" EXTRA HEIGHT	14-1/4"	7/16" ROUND
11247	REMOVABLE OFFSET HEAD REST MOUNT	10-1/4"	1/2" SQUARE
11248	REMOVABLE OFFSET HEAD REST MOUNT - 4" EXTRA HEIGHT	14-1/4"	1/2" SQUARE

Mounting holes

Please see page 14 for mounting adapter plates



Head Support



11680



19420



19412

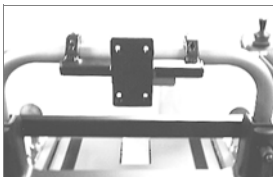

11680 mounted on chair

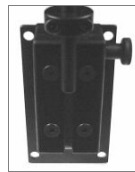

With mounting receivers installed



19410

Head rest adapter plates

Powder coated steel plates save you from redrilling and installing new t-nuts in back rests.

ITEM #	DESCRIPTION
11680	"PERMOBIL" CROSS BAR HEAD REST ADAPTER PLATE
19410	"OTTO BOCK" RECEIVER TO WOGTECH 1" X 2" T-NUT LAYOUT HEAD REST ADAPTER PLATE
19412	WOGTECH 1" X 2" RECEIVER TO "OTTO BOCK" T-NUT LAYOUT HEAD REST ADAPTER PLATE
19420	"LABAC" ALUMINUM BACK SHELL HEAD REST ADAPTER PLATE



19400



19405



19407

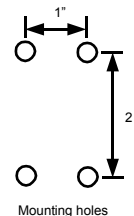

Mounting holes



Reverse view of 19407

1/4-20 threaded adapter plates

ITEM #	DESCRIPTION
19400	DOUBLE THREADED TAB ADAPTER PLATE
19405	DOUBLE THREADED TAB WITH WELDED PLATE ADAPTER
19407	FOUR HOLE THREADED BACKING PLATE ADAPTER



Head Support



Height adjustment bars

Round 7/16" diameter rod. Custom lengths available.

ITEM #	DESCRIPTION	ROD LENGTH	COLLAR TYPE
11500	HEIGHT ADJUSTMENT BAR - 7/16" ROD	4"	7/16" ROUND
11510	HEIGHT ADJUSTMENT BAR - 7/16" ROD	6"	7/16" ROUND
11520	HEIGHT ADJUSTMENT BAR - 7/16" ROD	12"	7/16" ROUND
11502	HEIGHT ADJUSTMENT BAR - 7/16" ROD	4"	1/2" SQUARE
11512	HEIGHT ADJUSTMENT BAR - 7/16" ROD	6"	1/2" SQUARE
11522	HEIGHT ADJUSTMENT BAR - 7/16" ROD	12"	1/2" SQUARE



Head Support



Height adjustment bars

Square 1/2" tubing. Custom lengths available.

ITEM #	DESCRIPTION	TUBE LENGTH	COLLAR TYPE
11504	HEIGHT ADJUSTMENT BAR - 1/2" SQ. TUBE	4"	7/16" ROUND
11514	HEIGHT ADJUSTMENT BAR - 1/2" SQ. TUBE	6"	7/16" ROUND
11524	HEIGHT ADJUSTMENT BAR - 1/2" SQ. TUBE	12"	7/16" ROUND
11506	HEIGHT ADJUSTMENT BAR - 1/2" SQ. TUBE	4"	1/2" SQUARE
11516	HEIGHT ADJUSTMENT BAR - 1/2" SQ. TUBE	6"	1/2" SQUARE
11526	HEIGHT ADJUSTMENT BAR - 1/2" SQ. TUBE	12"	1/2" SQUARE



Head Support



Head rest brackets

Custom lengths and hole patterns available.

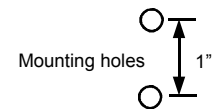

ITEM #	DESCRIPTION	LENGTH	TYPE
11600	HEAD REST BRACKET	4"	7/16" ROUND ROD
11610	HEAD REST BRACKET	6"	7/16" ROUND ROD
11620	HEAD REST BRACKET	4"	1/2" SQUARE TUBE
11624	HEAD REST BRACKET	6"	1/2" SQUARE TUBE

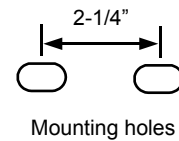

Close up of 11652
(for curved rear surface
of head rest pad)

Ball and socket head rest brackets

Custom lengths available.

ITEM #	DESCRIPTION	LENGTH	TYPE	USED FOR PAD TYPE
11650	BALL & SOCKET HEAD REST BRACKET	6"	7/16" ROUND ROD	FLAT
11655	BALL & SOCKET HEAD REST BRACKET	6"	1/2" SQUARE TUBE	FLAT
11652	BALL & SOCKET HEAD REST BRACKET	6"	7/16" ROUND ROD	CURVED
11657	BALL & SOCKET HEAD REST BRACKET	6"	1/2" SQUARE TUBE	CURVED



Head Support



11440



11452

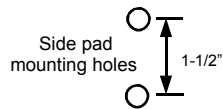
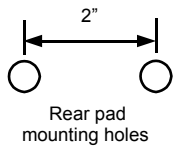

Close up of 11452 side pad



Side pads are independently adjustable in width and angle

Three piece multi-adjustable head rest

Available with or without pads. Pads are covered with water resistant/barrier stretch fabric.

ITEM #	DESCRIPTION	CENTER PAD SIZE	SIDE PAD SIZE
11440	THREE PIECE MULTI-ADJ. HEAD REST MOUNTING ONLY - NO PADS		
11450	THREE PIECE MULTI-ADJ. HEAD REST WITH SMALL PADS	5"W X 4"H	4"W X 3-1/2"H
11452	THREE PIECE MULTI-ADJ. HEAD REST WITH MEDIUM PADS	5"W X 4"H	5"W X 3-1/2"H
11454	THREE PIECE MULTI-ADJ. HEAD REST WITH LARGE PADS	6"W X 5"H	6"W X 4"H